

LT.	BY	DATE	REVISION
A	ST	02/27/12	ADDED METRIC DIMS, REVISED PRESSURES

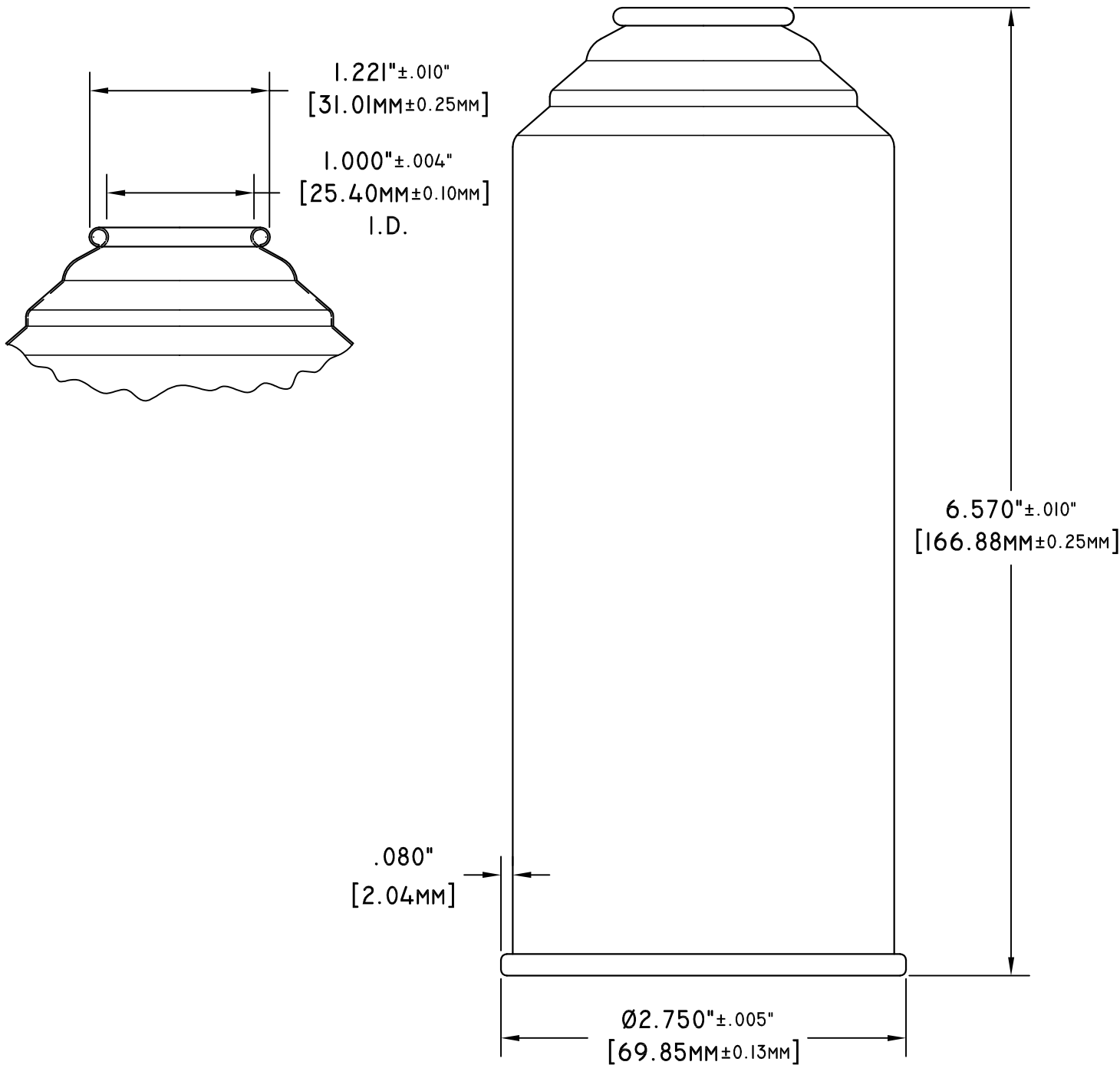

NOTES:

1. CONTAINER COMPLIES WITH SPECIAL PERMIT SP9393
2. VENT PRESSURE: 420 PSI [29 BAR] MIN. - 480 [33 BAR] MAX.
3. CAPACITY: 29.9 CU IN [490 ML]

DRAWN BY: *S.T.*
 CHECKED BY:
 APPROVED BY:
 TOLERANCES
 (EXCEPT AS NOTED)



3101 SEXTON ROAD
 DECATUR, AL. 35603-1453
 PHONE: (256)355-5850
 FAX: (256)351-8730

THE GREEN LOGO
 INDICATES A CONTROLLED
 DOCUMENT. IF THE LOGO
 APPEARS BLACK, THIS
 PAGE IS CONSIDERED TO
 BE USED FOR TRAINING OR
 REFERENCE ONLY.

DECIMAL XXX .005	TITLE: 211 x 512 AEROSOL WITH R-22 BOTTOM (A88)		
DECIMAL XX .01	LINE#: NA	DATE: 02/27/12	DRAWING : 998D0088
ANGLE .25°	SCALE: 1 : 1	MATERIAL: NA	
			A